

# Wall Mounted Controller

Single Colour



## Features

- Touch panel controller for single colour constant voltage
- Ultra-sensitive high strength glass touch panel with touch colour wheel in the middle
- Compatible with our wireless 2.4G remote range
- Touch keys with chord tones and LED indicator

Codes	
Black	LCDMSD-T1-B
White	LCDMSD-T1-W
Input and Output	
Input voltage	12-24VDC
Input current	12.5A
Output voltage	4 x (12-24) VDC
Output current	4CH,3A/CH
Output power	144-288W
Output type	Constant voltage
Light type	Single colour

Safety and EMC	
EMC standard (EMC)	EN301 489,EN 62479
Safety standard (LVD)	EN60950
Radio Equipment (RED)	EN300 328
Certification	CE, EMC, LVD, RED
Environment	
Operation temperature	Ta:-30°C~ +55°C
Max case temperature	Tc:+85°C
IP rating	IP20
Warranty and Protection	
Warranty	5 years
Protection	Reverse polarity

## Mechanical Structures & Installation

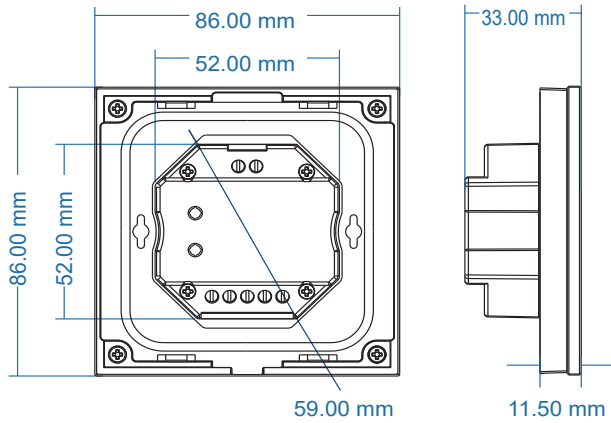

Typical base as below:

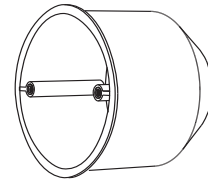

European style

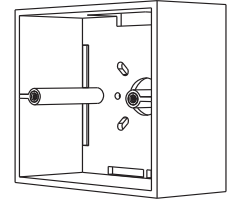

86 size

Installation diagram:

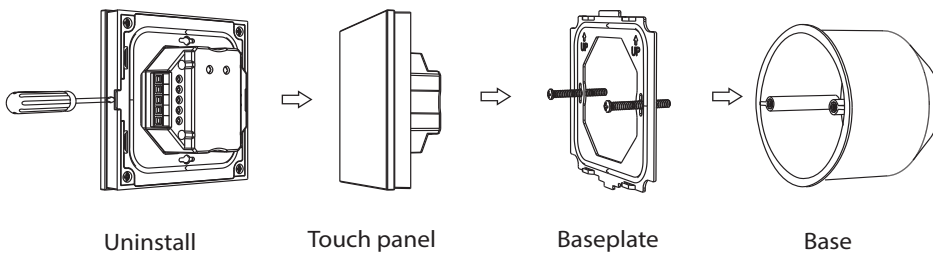



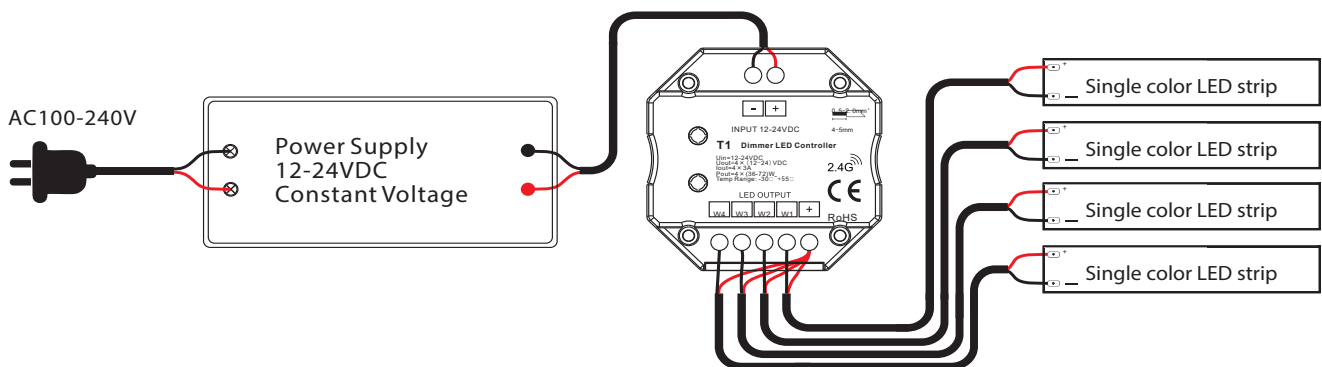

## Wiring diagram

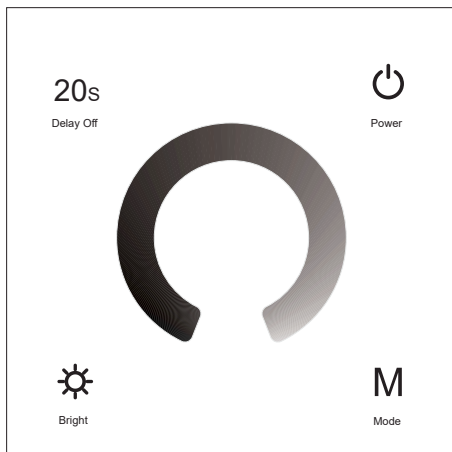

## Key Functions



-  — Turn on/off light
-  — Brightness wheel
-  — Brightness, 10 levels
-  — Turn off light after 20 seconds
-  — Dynamic mode, 6 level speed

## Matching to an RF remote

The touch panel controller can also match with the RF remote (optional). End user can choose the suitable match/delete ways. Two options are offered for selection:

### Use On/Off key

#### Match:

Turn on light, turn off, immediately press the On/Off key of the panel for 5s, then press on/off key (single zone remote) or zone key (multiple zone remote) of the RF remote within 5s. The LED indicator fast flash 3 times means match is successful.

#### Delete:

Turn on light, turn off, immediately press the On/Off key of the panel for 10s, delete all matched RF remote. The LED indicator fast flash 6 times means all matched remotes were deleted.

### Use Power Restart

#### Match:

Switch off the power, then switch on power, repeat again, immediately short press on/off key (single zone remote) or zone key (multiple zone remote) 3 times on the remote. The light blinks 3 times means match is successful.

#### Delete:

Switch off the power, then switch on power, repeat again, immediately short press on/off key (single zone remote) or zone key (multiple zone remote) 5 times on the remote. The light blinks 5 times means all matched remotes were deleted.