

LEDCHAN210 SURFACE MOUNTED INSTALLATION INSTRUCTIONS

Extrusion installation:

Tools required:

- #5 gauge pan head screws maximum, for clips.
- Glue or tape fix may be appropriate.

1) If direct screw fix method is to be used select the smallest available screws that will adequately retain the extrusion. These must be of a countersunk type in #3 or #4 gauge size. The LED strip must be allowed to lie flat against the extrusion. This not only preserves the thermal pathway for the LEDs, but also prevents any strange optical artefacts from being visible in the result. Ensure all screws are recessed before continuing.

2) Plan to use a clip approximately every 500mm.

3) Mitred corners need to be very accurate in order to have tight joints and low light leakage. Task recommends cutting the diffusers mounted in an off-cut of channel and temporarily held with tape for workholding. All cuts should be made slowly on a quality compound drop saw. Back fill the joints with adhesive foil tape to eliminate light leakage from the joint.

4) Read separate Electrical Installation Instructions for subsequent electrical assembly.

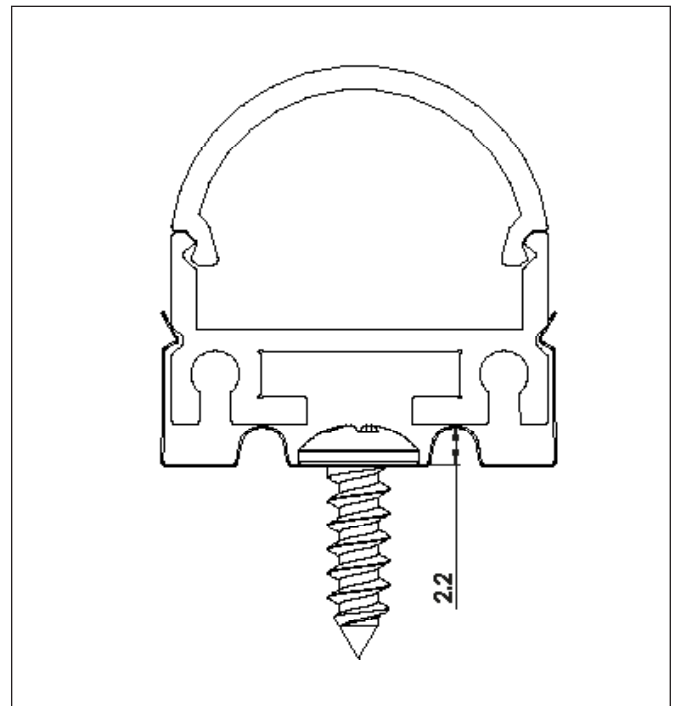

fig 1. channel with clip installed using #5 pan head screws

Notes:

- Cover diffusers are not UV stabilized and will become brittle in outdoor environments.
- Drivers are remote mounted only

fig 2. Channel end detail showing clip fastening installed

