

## LDNF400

3D Bendable Neon Flex IP67

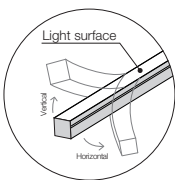

**3D Bending**  
Vertical & Horizontal bending

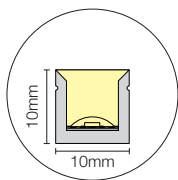
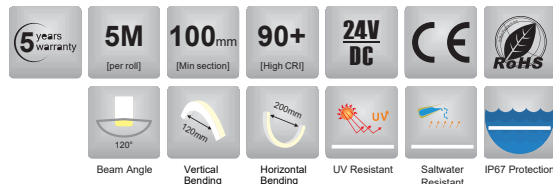

### Features

- Slim design 10x10mm
- Dot free illumination
- IP67 protection
- 24V Constant Voltage
- Suitable for vertical or horizontal bending
- Available with bottom or end connection
- UV protection and salt water resistant
- 3 year warranty

## Product Information

<b>Code</b>	LDNF400-3K-EF-5M	LDNF400-3K-BF-5M	LDNF400-4K-EF-5M	LDNF400-4K-EF-5M
<b>Colour temp</b>	3000K		4000K	
<b>Lumen output</b>	600Lm/m		690Lm/m	
<b>CRI</b>	90+			
<b>Power/m</b>	8W/m			
<b>Efficacy</b>	76Lm/W		86Lm/W	
<b>Input Voltage</b>	24VDC			
<b>Dimmable</b>	Yes by PWM			
<b>Cut length</b>	100mm			
<b>Connection</b>	End	Bottom	End	Bottom

## Dimensions (mm)

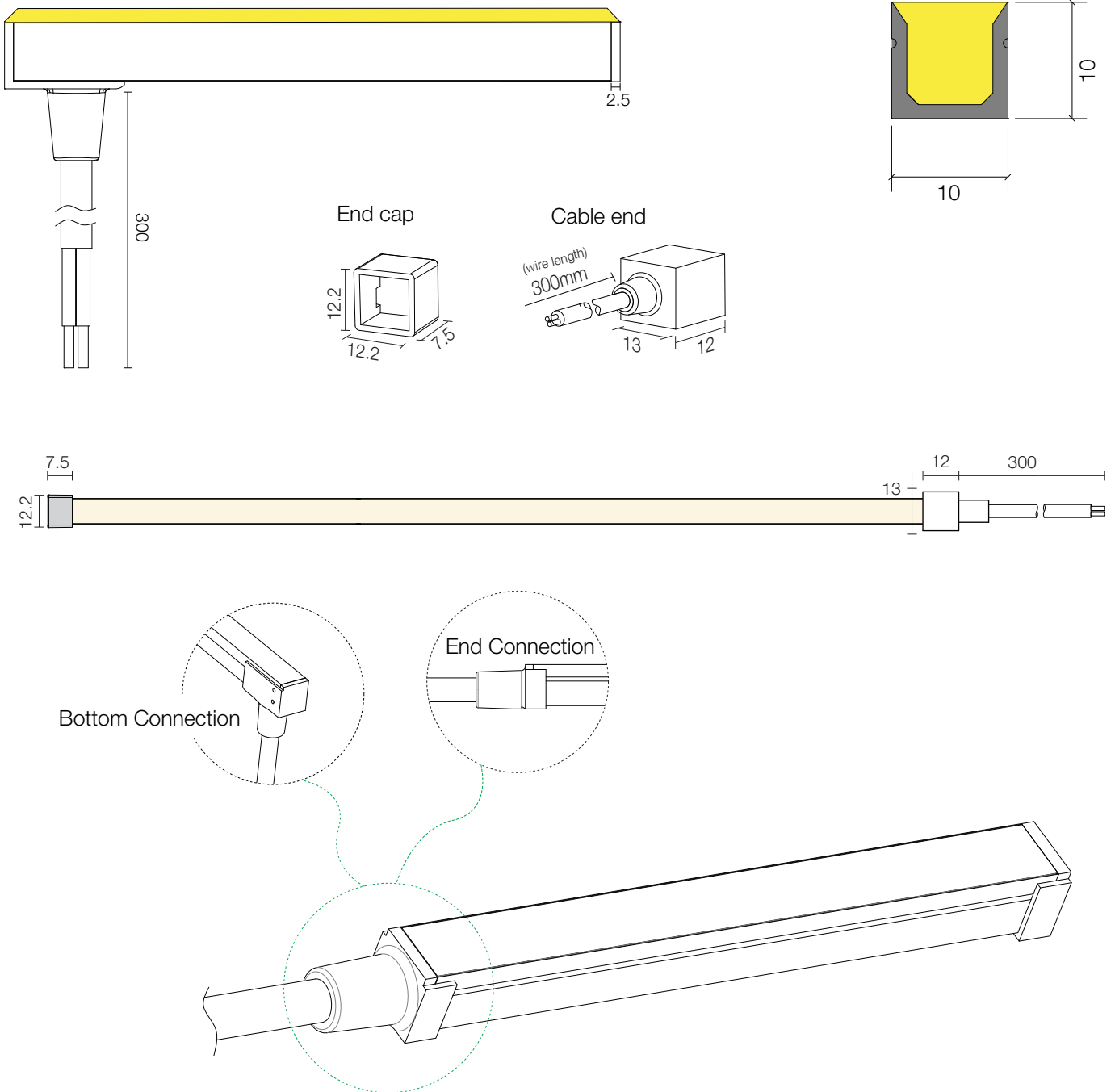

# Accessories

## Aluminium Clips

Code: LDNF400-AC

Length: 25mm

Spacing: 500mm

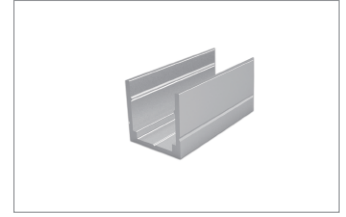
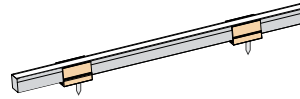
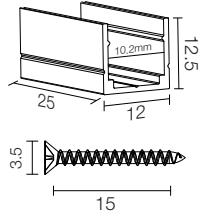

## Aluminium Profile

Code: LDNF400-AP

Length: 1000mm

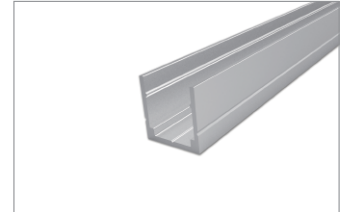
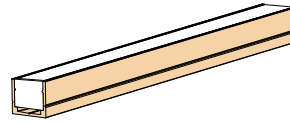
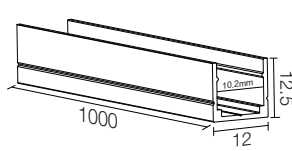

## Stainless U Channel

Code: LDNF400-FST

Length: 1000mm

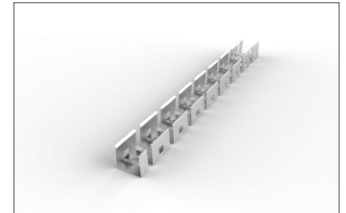
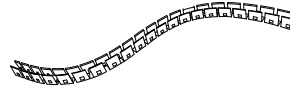
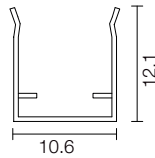

# Luminous Intensity Distribution

3000K

1M

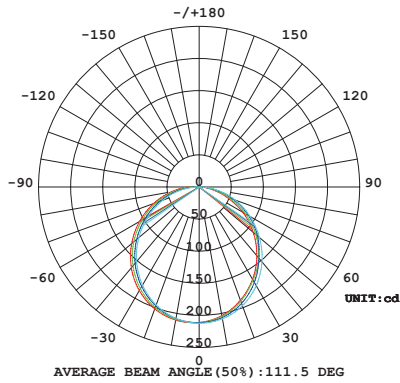

- C0/180, 111.7 Ic=211.7
- C30/210, 112.0 Ic=211.3
- C60/240, 111.6 Ic=211.3
- C90/270, 110.6 Ic=212.1

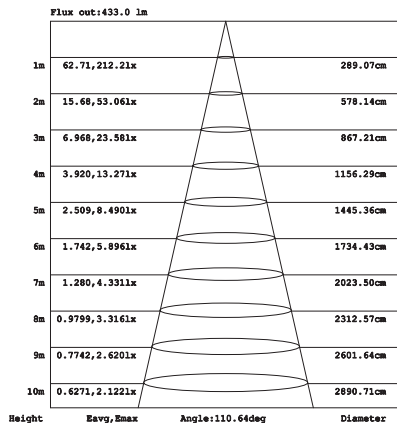

4000K

1M

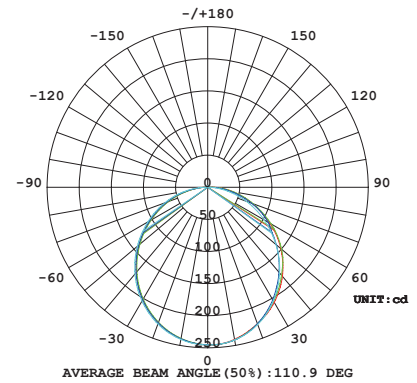

- C0/180, 111.7 Ic=245.4
- C30/210, 112.0 Ic=245.4
- C60/240, 109.8 Ic=245.3
- C90/270, 110.0 Ic=245.5

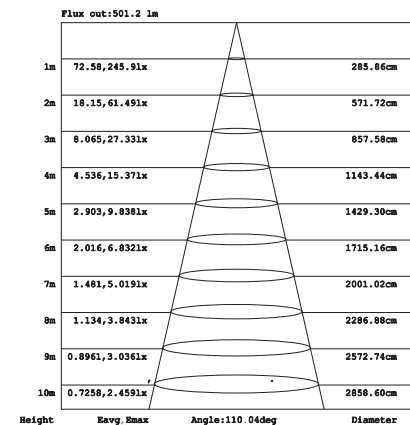

# Bend Directions

## Neon Profile

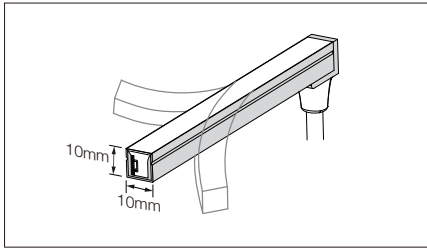

## Bend Direction

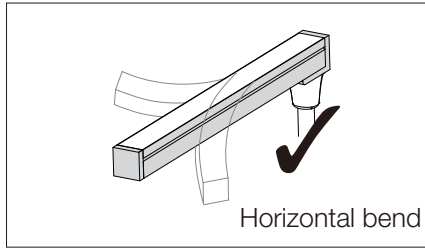

Horizontal bend

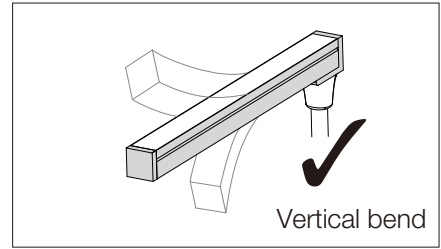

Vertical bend

## Correct Bending Direction

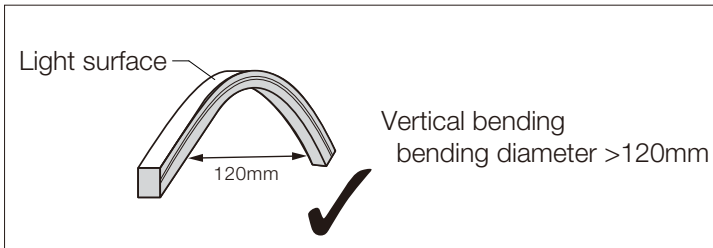

Vertical bending  
bending diameter >120mm

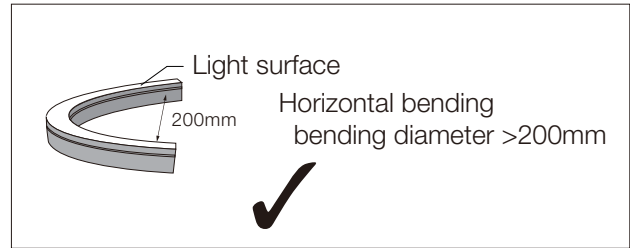

Horizontal bending  
bending diameter >200mm

## Incorrect Bending Direction

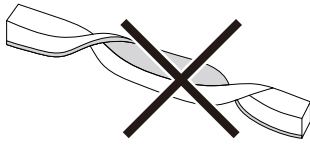

(As shown above)  
Please do not twist the strip, or it will be damaged.